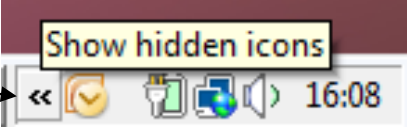

Troubleshooting

Before you contact us, try the things below

 Not Connected to franking machine	<p>Try closing the MailCredit software by right clicking on the icon and choosing 'Exit'</p> <p>Then start the MailCredit software again by double clicking the MailCredit icon on the desktop</p> <p>Have you plugged the cable into the franking machine and the USB end into your PC?</p> <p>Try a different USB port</p>
<p>The cable won't fit into the rear of my franking machine</p>	<p>Make sure that the cable faces the rear of the machine when connecting</p>
<p>The USB cable is not recognised by my computer</p>	<p>Try plugging the cable into a different USB port</p> <p>Try restarting the PC</p>
<p>Which operating systems will MailCredit work with?</p>	<p>MailCredit will work with Windows XP, Vista* and Windows 7*, it will not work with Mac OS, *There are other drivers for these operating systems on the CD provided</p>
<p>I have downloaded MailCredit but I can't see it on my PC</p>	<p>Try right clicking on the desktop and choosing 'Refresh'</p> <p>Have you checked 'My Documents' and then 'Downloads'?</p>
<p>I don't see the MailCredit icon in my taskbar but I have double clicked the program to run it</p>	<p>Click this button</p> 

MailCredit pack

Please read this 10 step guide before attempting to install MailCredit



QUICK GUIDE for Windows XP (see back page for other operating systems)

1 Check the contents of the box

- Connection cable for your opti franking machine
- USB—serial adapter with install CD (you will need this in step 5)

2 You will have already downloaded the MailCredit software along with this Installation Guide so make sure you have saved this to your PC desktop to make it easier to find in steps 7 and 9

3 Double click the MailCredit software file on your desktop to install it on your PC or laptop

4 Remove the telephone cable from the rear of the opti

Plug the cable into the rear of your opti

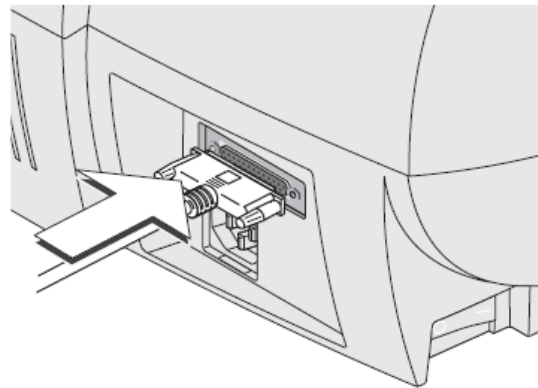

5 Join the USB adapter to the cable you have selected for your machine and insert the mini CD into your CD drive and install the relevant drivers for your operating system

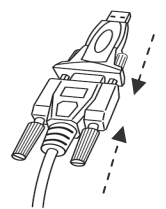

6 Plug the other end of the cable into a USB port of your PC or laptop (windows will inform you when the device is ready)



7 Run the MailCredit software make sure the opti is in the home screen (press and hold the 'BACK' button)

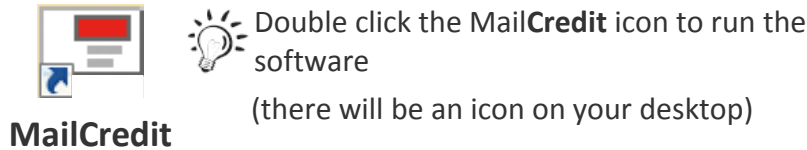

8 Test connection to the franking machine, make sure the opti is in standby mode

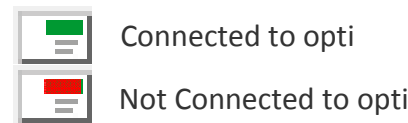

you will see an icon in your PC taskbar (by the clock)

9 Set up your opti to use mailcredit

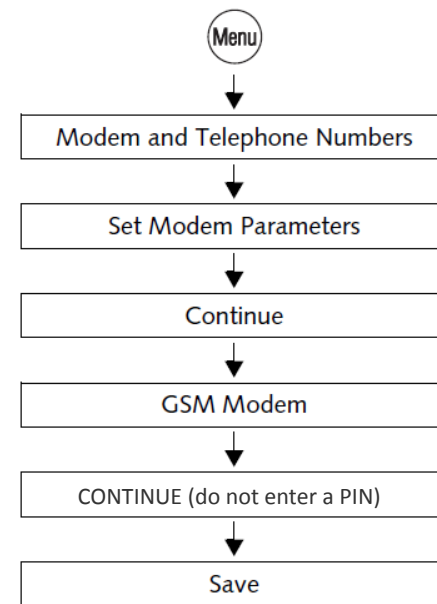

Test the connection from the opti to the Internet (right click the MailCredit icon on your PC and choose 'Status')

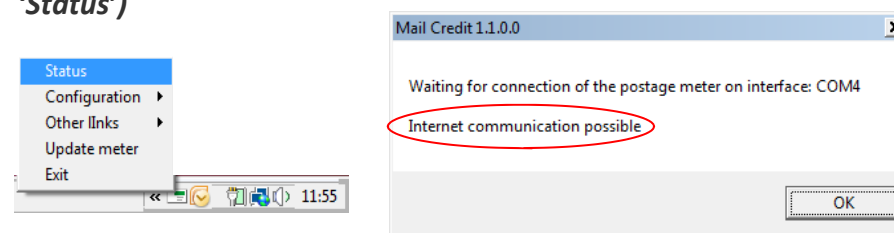

10 Try a test postage download using MailCredit (zero amount is sufficient)

Just download postage in the normal way from the opti, opti will use the connection to the PC to download postage

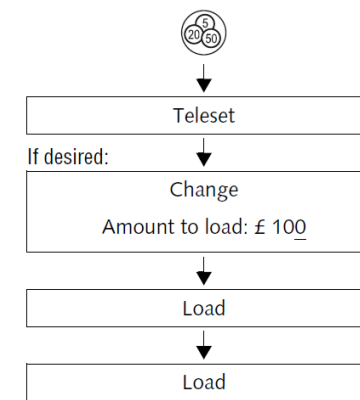

- Press the key.
 - Select TELESET to call up the loading procedure.
 - Accept the amount to be loaded.
Or Use CHANGE to open the menu for the amount to be loaded. Type the desired amount.
 - Confirm with LOAD.
- The opti displays the set amount for checking purposes.
- To load the displayed amount:
- Use LOAD to establish the connection to the Teleset Data Centre.
- Loading continues automatically. You can monitor the progress in the display. Please stand by. Data exchange takes some time.

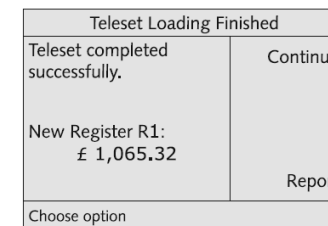

- The new residual amount is indicated when loading ends.
- Use REPORT to view and print the loading report.
- Select CONTINUE to finish the loading procedure.

You can use MailCredit to download postage via your pc from now on, just make sure that the opti is connected to your PC instead of the telephone line using your MailCredit cable and download postage into the opti as normal